

Assembly Instruction Samlevejledning

1053389 Dice Reol, 2 låger og 4 hylder

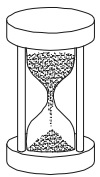

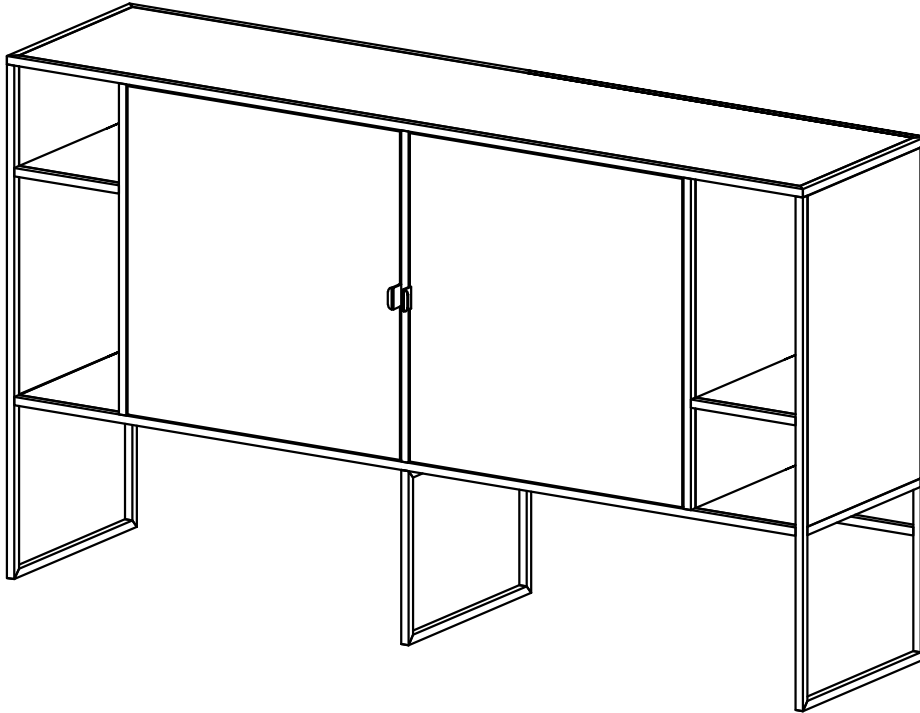

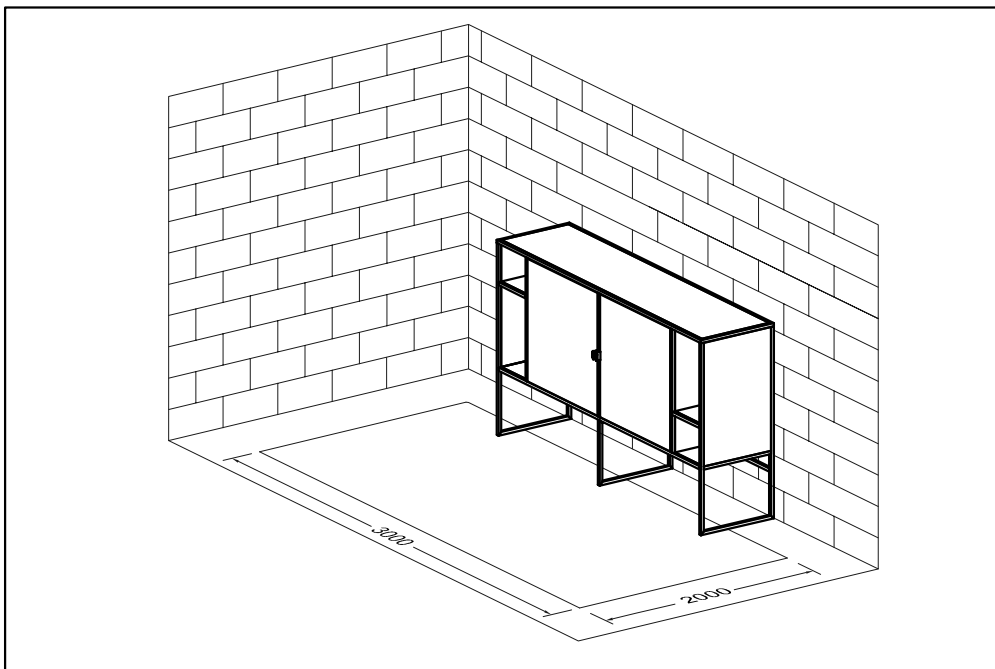

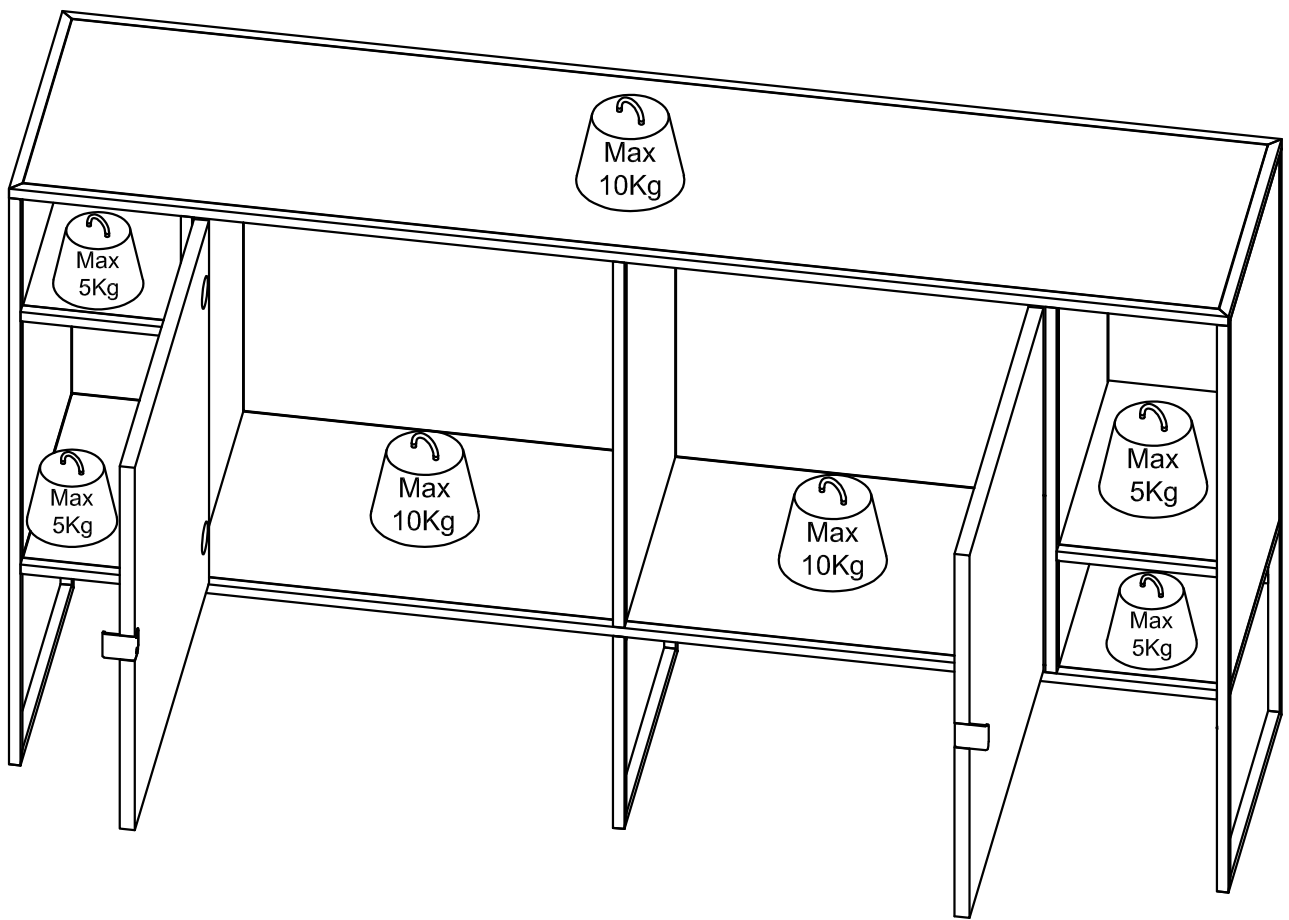
15 MIN



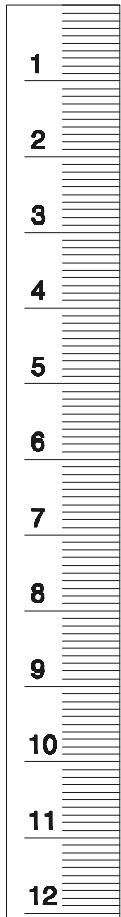
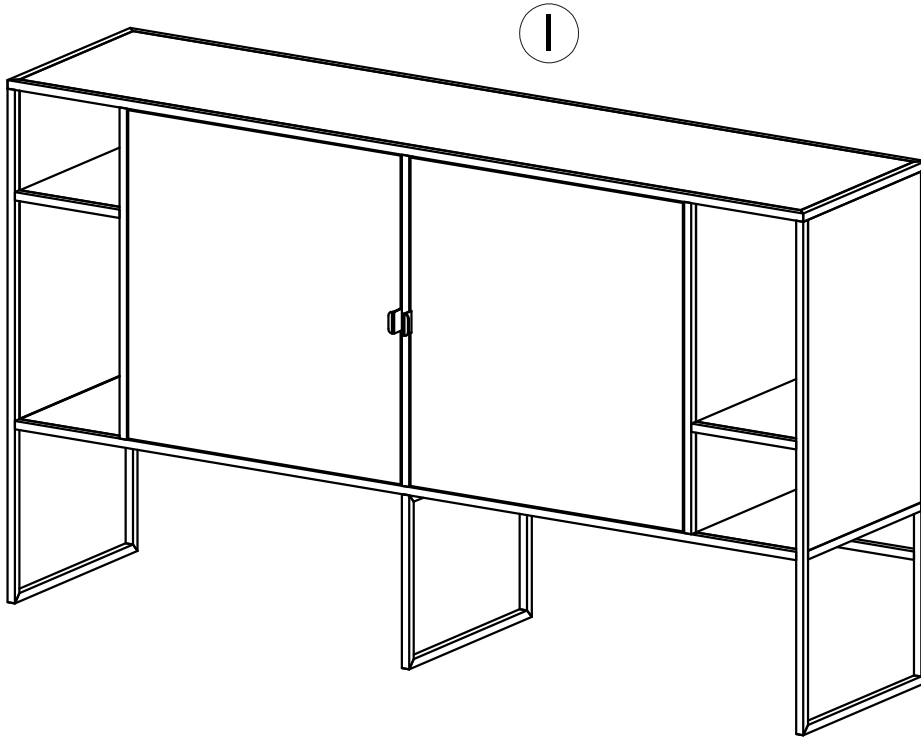

PART ID	QUANTITY	DIMENSIONS (mm)	✓
I	1	1300 x 320 x 750	

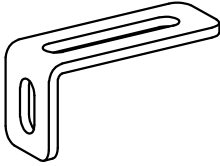

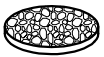
<p>A = 02 PCS <input type="checkbox"/></p>  <p>Mushroom bolt M4x10 mm</p>	<p>B = 02 PCS <input type="checkbox"/></p>  <p>Wall Bracket 15x20x40 mm</p>	<p>C = 02 PCS <input type="checkbox"/></p>  <p>Flat Washer Ø12x1 mm</p>	<p>D = 9 PCS <input type="checkbox"/></p>  <p>Felt Ø10x2 mm</p>
--	--	---	--

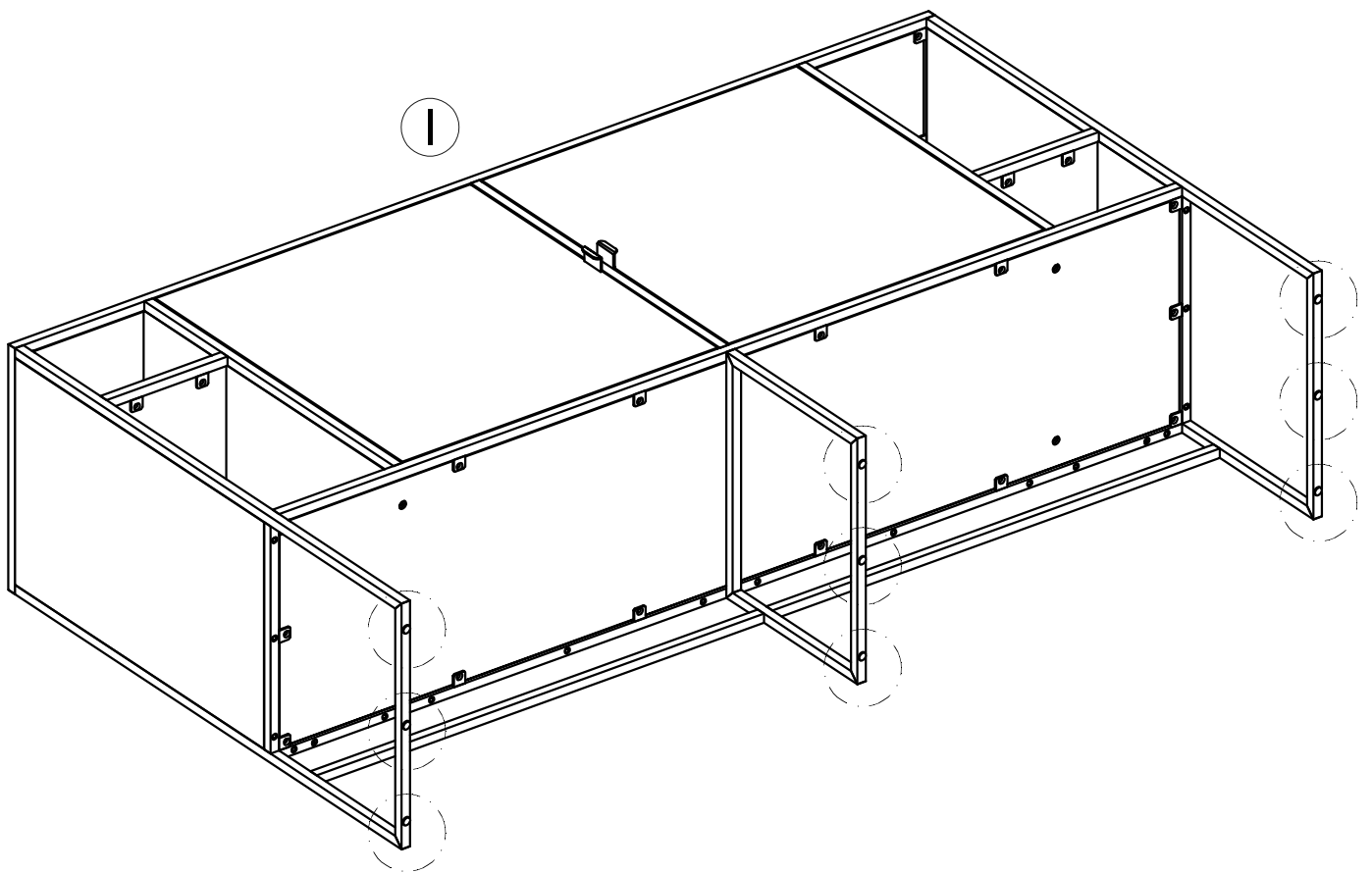
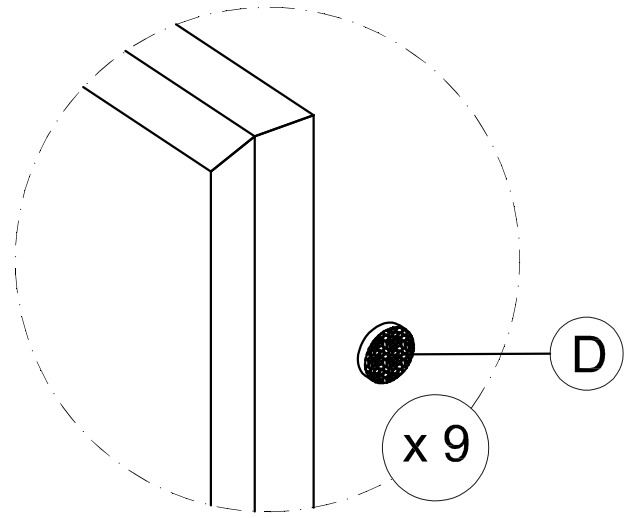

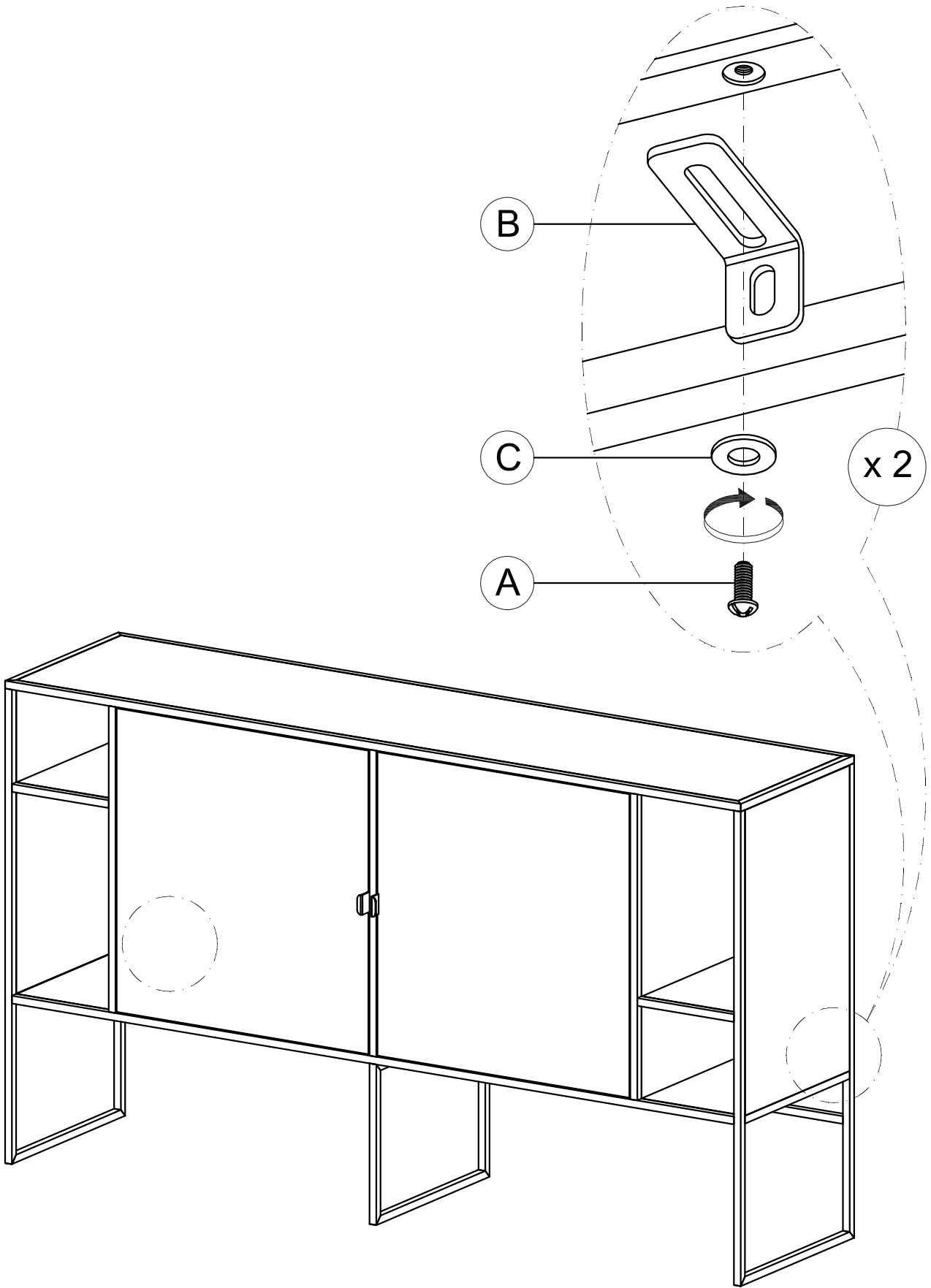

Fittings not supplied with this product
Skruer/rawplugs til vægmontering medfølger ikke

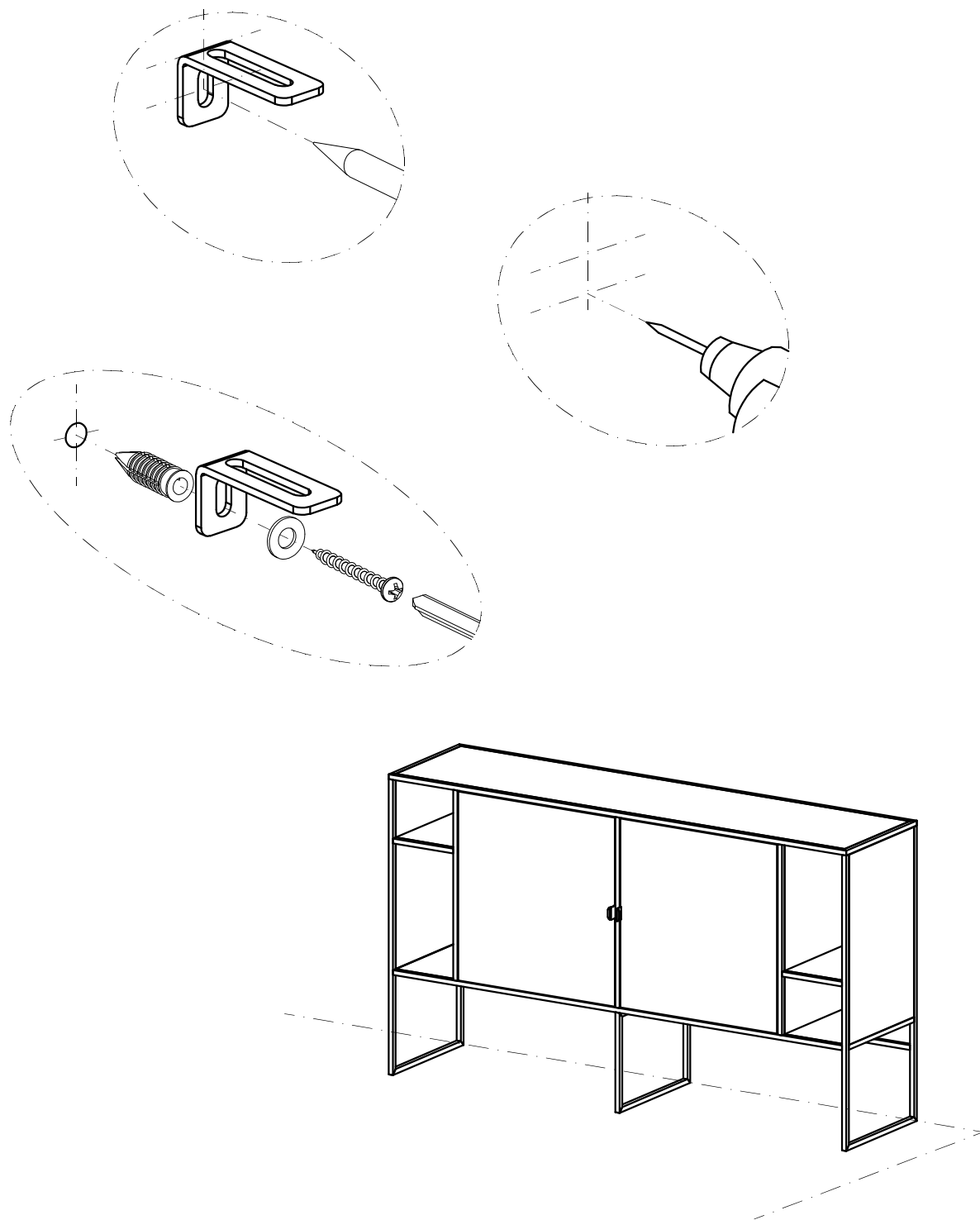

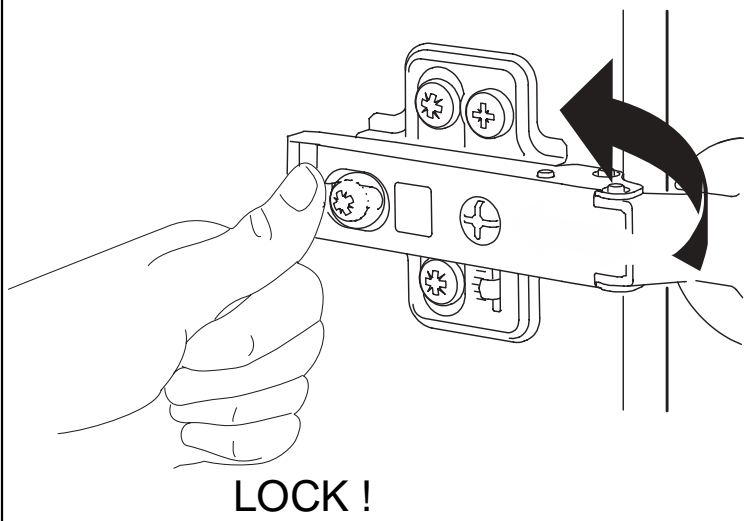

LOCK !

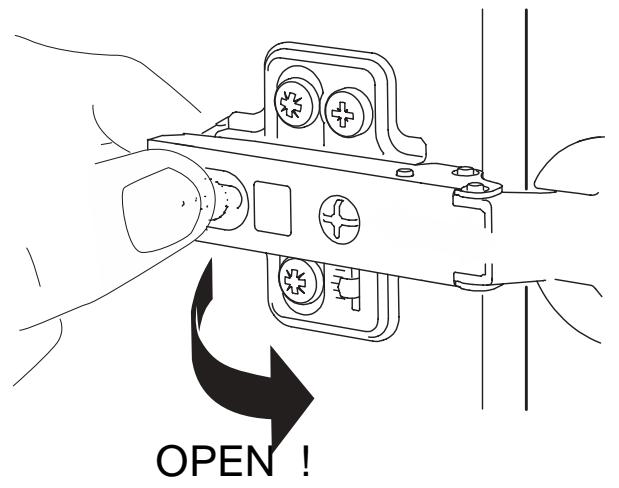

OPEN !

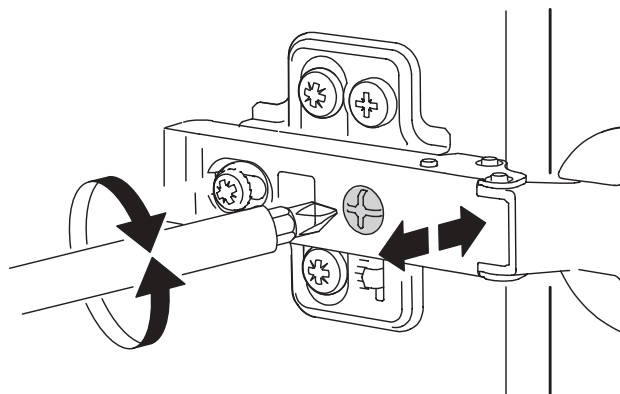
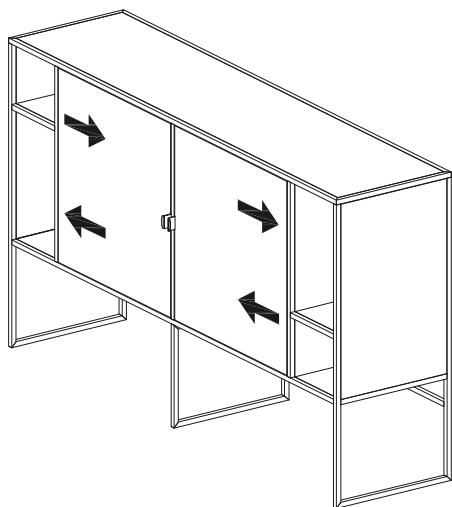
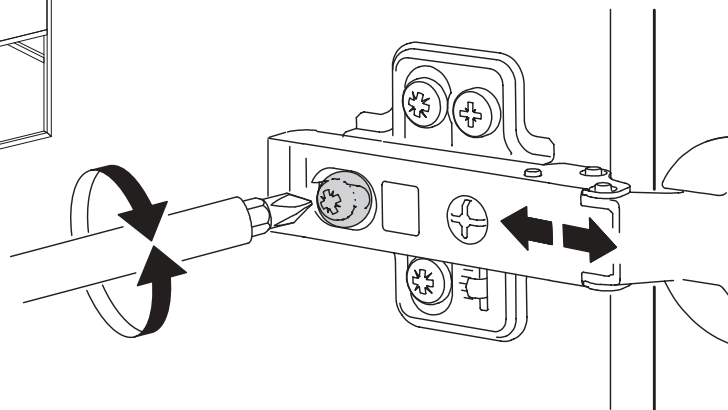
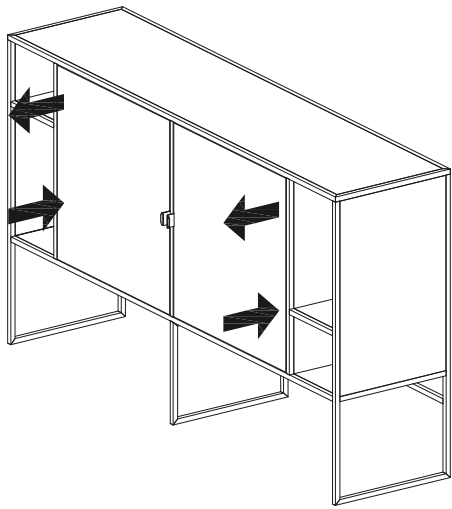

DE

Sehr geehrter Kunde!

Wir beglückwünschen Sie zum Kauf Ihres neuen Möbelstücks aus lackiertem Eiche Furnier.

Um Ihnen viele Jahre Zufriedenheit mit Ihrem neuen Möbelstück zu sichern, ist es notwendig, die richtige Pflege durchzuführen. Bitte befolgen Sie folgende Richtlinien, die für lackierte Oberflächen gelten, dann garantieren wir Ihnen, dass Ihre Möbel sich in den zukünftigen Jahren schön und gepflegt halten. Wir empfehlen Ihnen, dass Sie Ihren Möbelhändler bei jeder Frage um Rat fragen.

Tägliche Pflege:

1. Mit einem weichen Tuch, ausgewrungen in sauberen, warmen Wasser, abwischen. Benutzen Sie nie Spülmittel oder Schmierseife.
2. Farbflecken wie z. B. Rotebeetesaft, Rotwein oder dergleichen muss sofort abgewischt werden.
3. Vermeiden Sie extreme Feuchtigkeit und Hitze, stellen Sie nie Möbelstücke in der Nähe von Heizquellen wie z. B. Heizkörper auf.
4. Die Beine der Ess- und Sofatische müssen regelmäßig nachgespannt werden.

ENG

Dear Customer,

Congratulations on your purchase of a piece of furniture made from lacquered, veneered oak.

To make sure that you will enjoy many years of satisfaction with your piece of furniture, it is imperative with the right care and maintenance. Kindly follow the below guidelines, and we guarantee that your unit will stay beautiful in the years to come. It is our recommendation that you ask your furniture supplier for advice in any instance.

Daily maintenance:

1. Clean the surface with a clean, wrung out cloth. Never use detergents
2. Coloured stains like red wine must be dried off immediately
3. Avoid extreme humidity and heat. Do not place the item close to heat sources
4. Legs for coffee and dining tables must be fastened occasionally

DK

Kære kunde,

Hjertelig tillykke med købet af Deres nye møbel i lakeret, fineret egetræ.

For at sikre Dem mange års tilfredshed med Deres nye møbel, er det nødvendigt med den rette pleje og vedligeholdelse. Venligst følg nedenstående retningslinjer, så garanterer vi Dem, at Deres møbel holder sig smukt i årene fremover: Det er vores anbefaling, at de spørger møbelsælgeren til råds om ethvert spørgsmål.

Daglig pleje:

1. Aftørring med en blød klud, hårdt opvredet i rent, varmt vand. Brug aldrig sulfo eller brun sæbe
2. Farvepletter som f.eks. rødbedesaft, rødvin og lignende skal aftørres omgående
3. Undgå ekstrem fugt eller varme, og stil aldrig møblet i nærheden af varmekilder som f.eks. radiatorer
4. Benene til spise- og sofaborde skal efterspændes regelmæssigt