

Rocca/Caracas

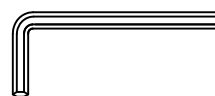

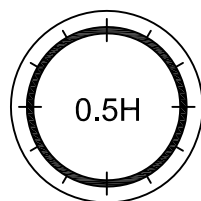

① x1

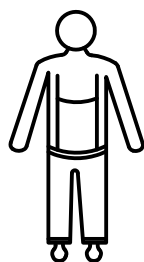
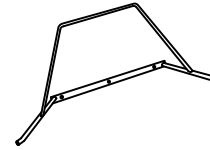

② x1

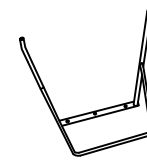

③ x1

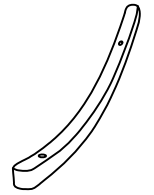

④ x2

A*4



M8*25

B*6



M8*15

C*2



M4*15

D*4



E*4



F*1



G*1



01

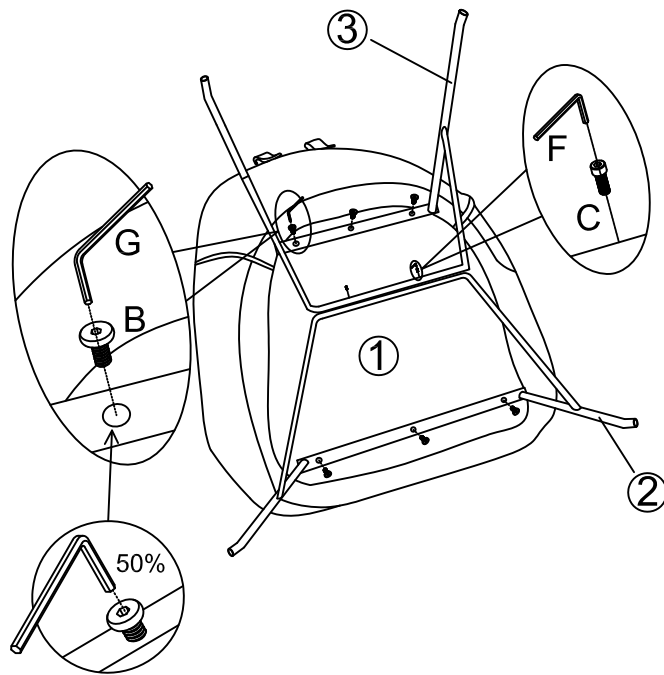

02

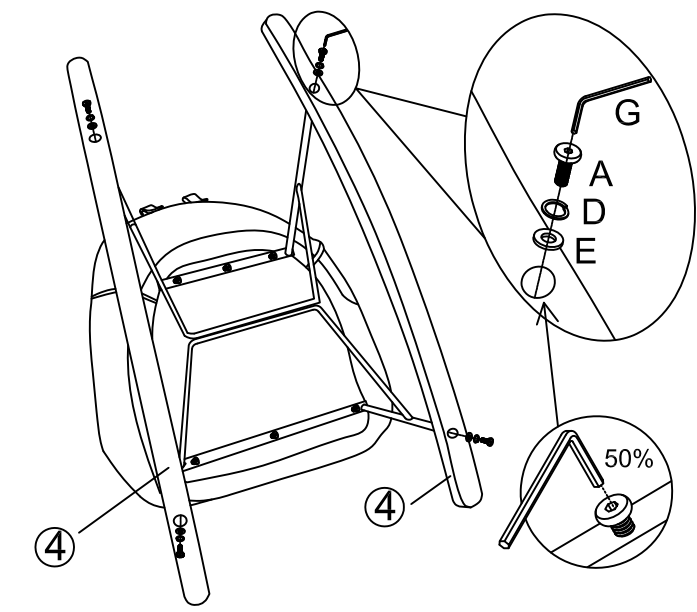

03

