

ASSEMBLY INSTRUCTION

CALVI
1055403

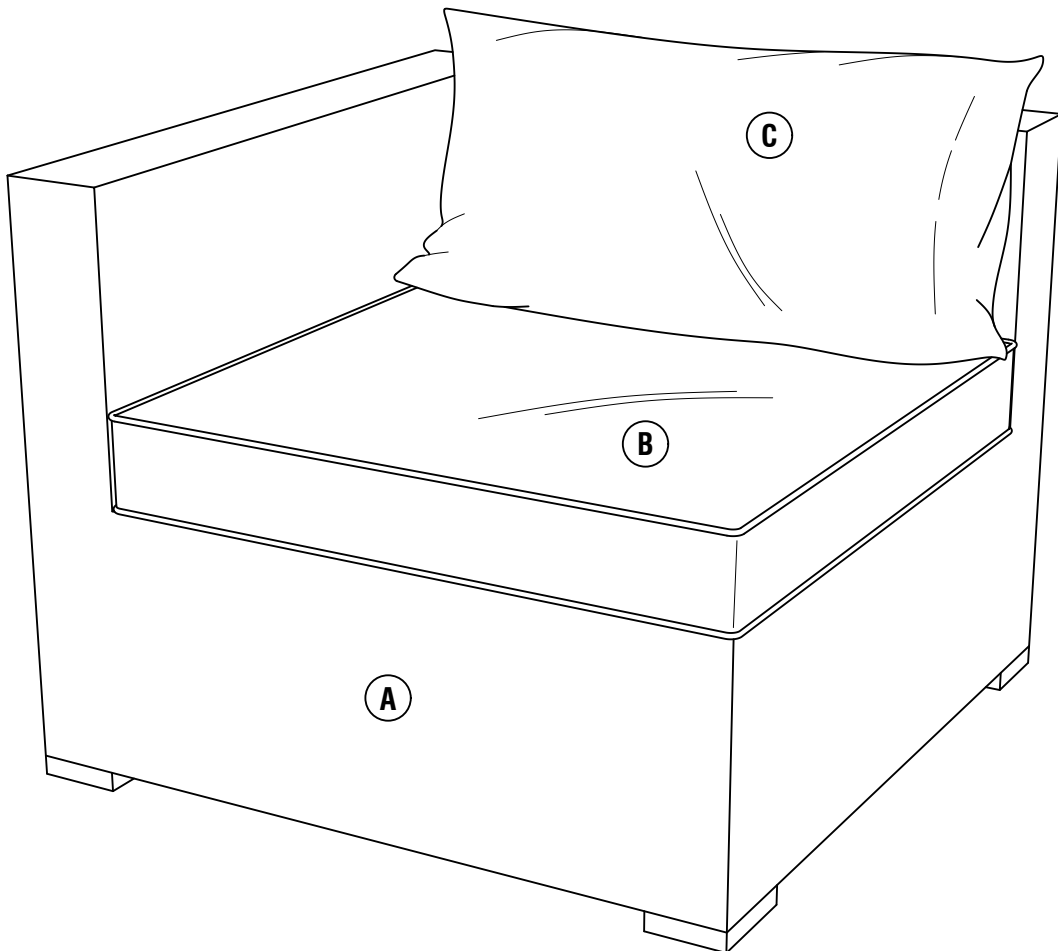

88 x 88 x 66 cm

18-08-2022

ILVA

Kære Kunde

Tillykke med dit nye køb.
Følg disse råd og få det bedste resultat, når du samler produktet.

Læs vejledningen grundigt, før du går i gang.
Find hjælp, hvis I skal være to til at samle møblet.
Tjek at pakken indeholder alle dele på materialeoversigten.
Saml møblet på et blødt underlag, så du undgår ridser.
Følg vejledningen nøje.
Efterspænd møblet efter en måned.
Gem denne vejledning.

Afsæt god tid.

Nogle møbler kan samles på få minutter. Andre - der f.eks. består af flere dele - kan tage over en time at samle. Afsæt god tid eller gør evt. arbejdet af flere omgange.

Mangler du enkeltdele, eller har du spørgsmål til Samvejledningen kontakt kundeservice på ilva.dk.

Venlig hilsen
ILVA



Anbefalet:

Dear Customer

Congratulations on your new purchase.
Follow this advice and get the best Result when assembling the product.

Read the instruction carefully before you start.
Get help, if two persons are required for assembly.
Make sure, you have all parts on the total material list.
Work on a soft, flat surface to avoid any damage to the finish.
Follow the assembly instruction.
Tighten the furniture joints after a Month.
Keep the assembly instruction.

Allocate good time

Some furniture can be assembled in minutes. Others - e.g. products in several parts - can take more than an hour to finish. Make sure to allocate good time or divide up the work.

If any parts are missing or you have questions for the Assembly instruction contact support at ilva.dk.

Best regards
ILVA



Recommended:

Warning!!!

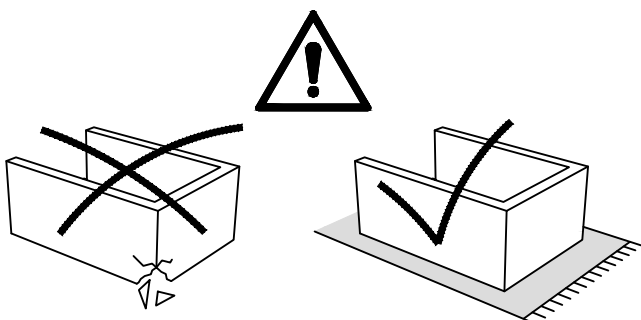

TOTAL MATERIAL LIST, HARDWARE

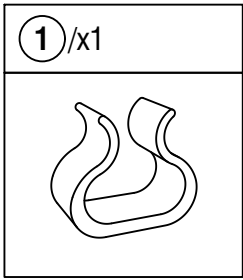

TOTAL MATERIAL LIST, FURNITURE PARTS

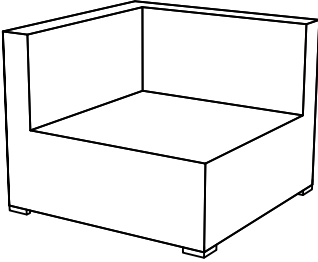
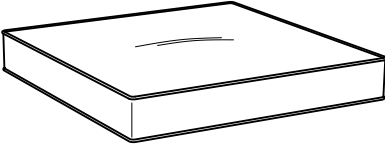
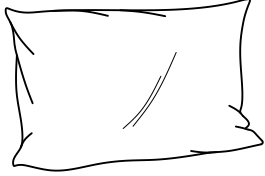
A/x1	B/x1	C/x1
		

MATERIAL LIST

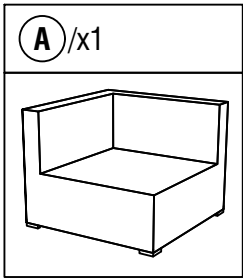

ASSEMBLY INSTRUCTION, 1

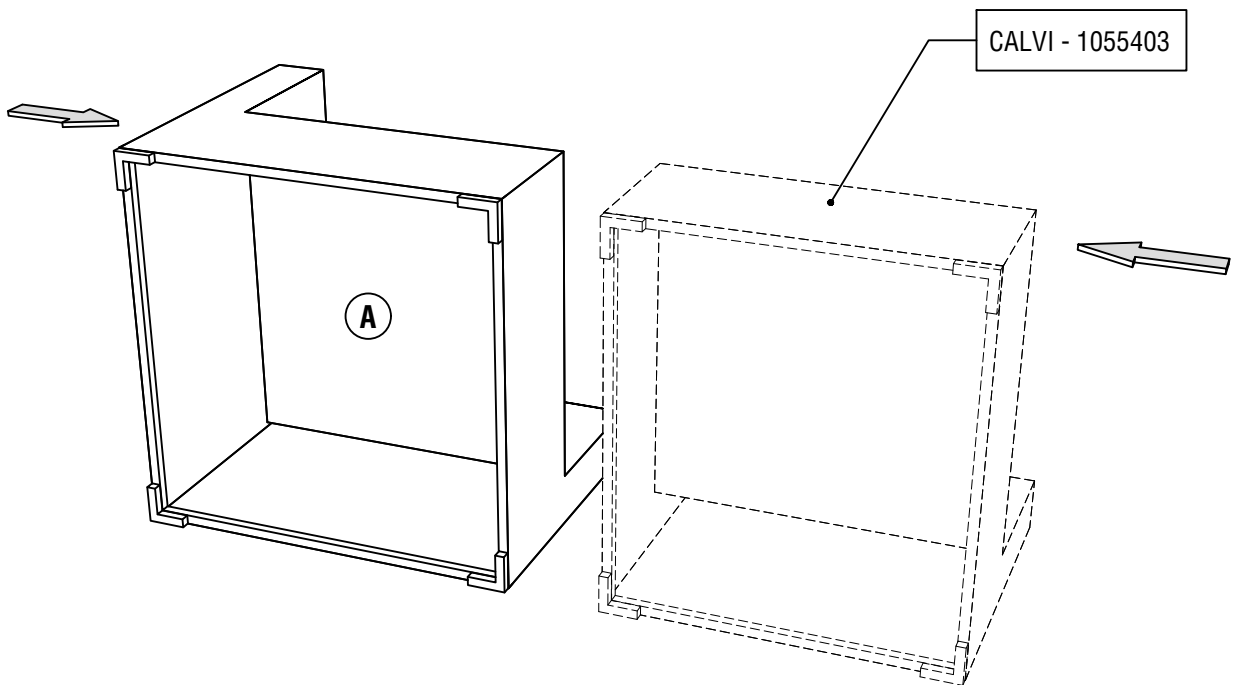

ASSEMBLY INSTRUCTION, 2

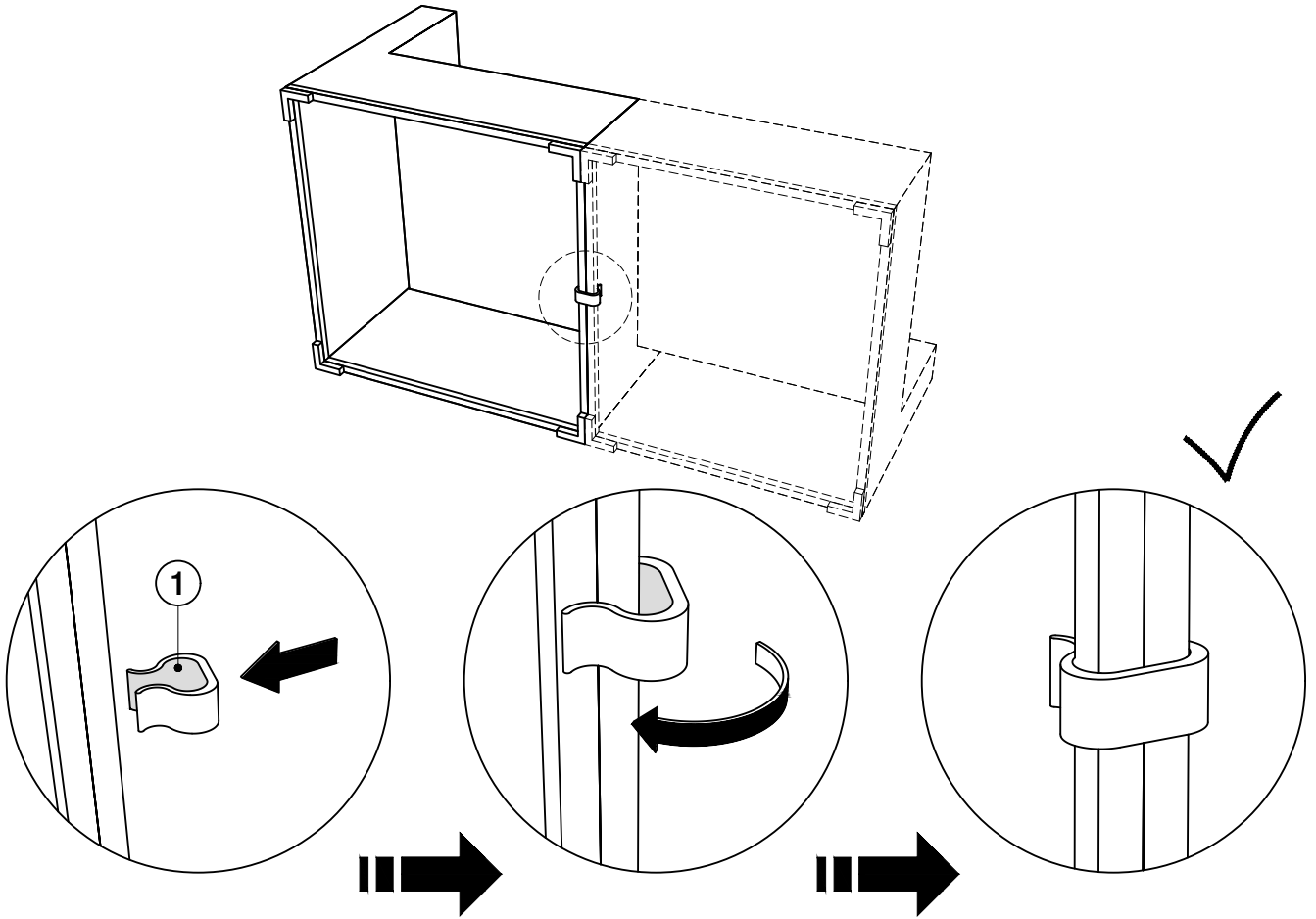

ASSEMBLY INSTRUCTION, 3

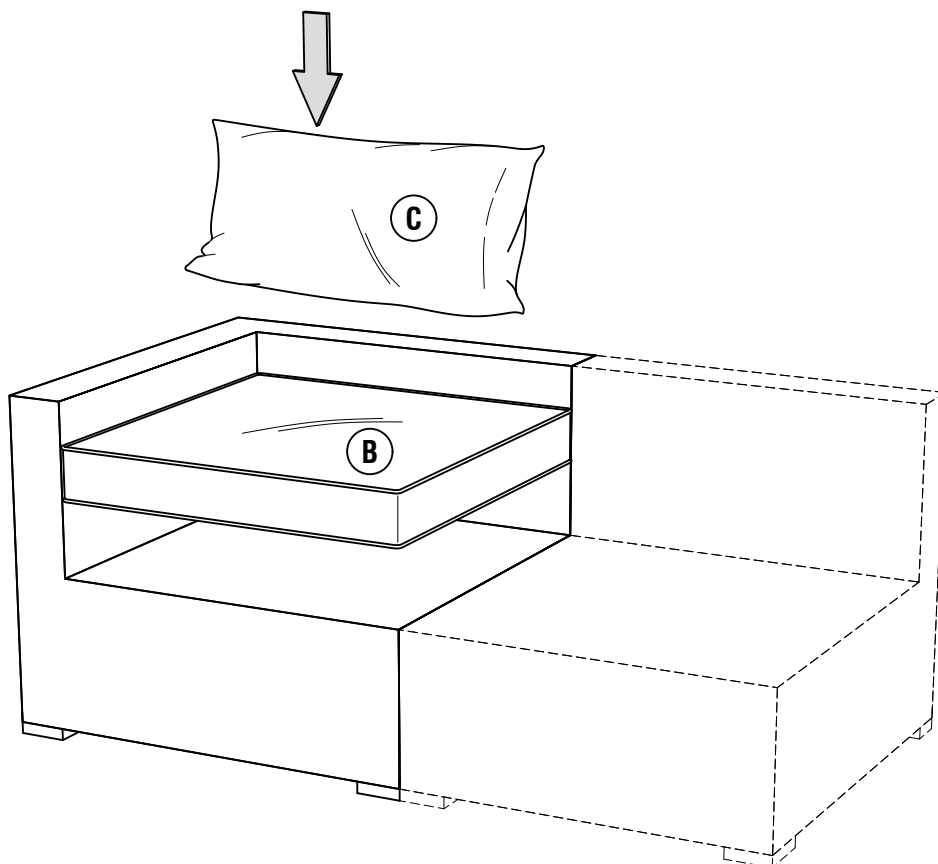

MAX LOAD

