

Assembly Instruction

Colton
1073869

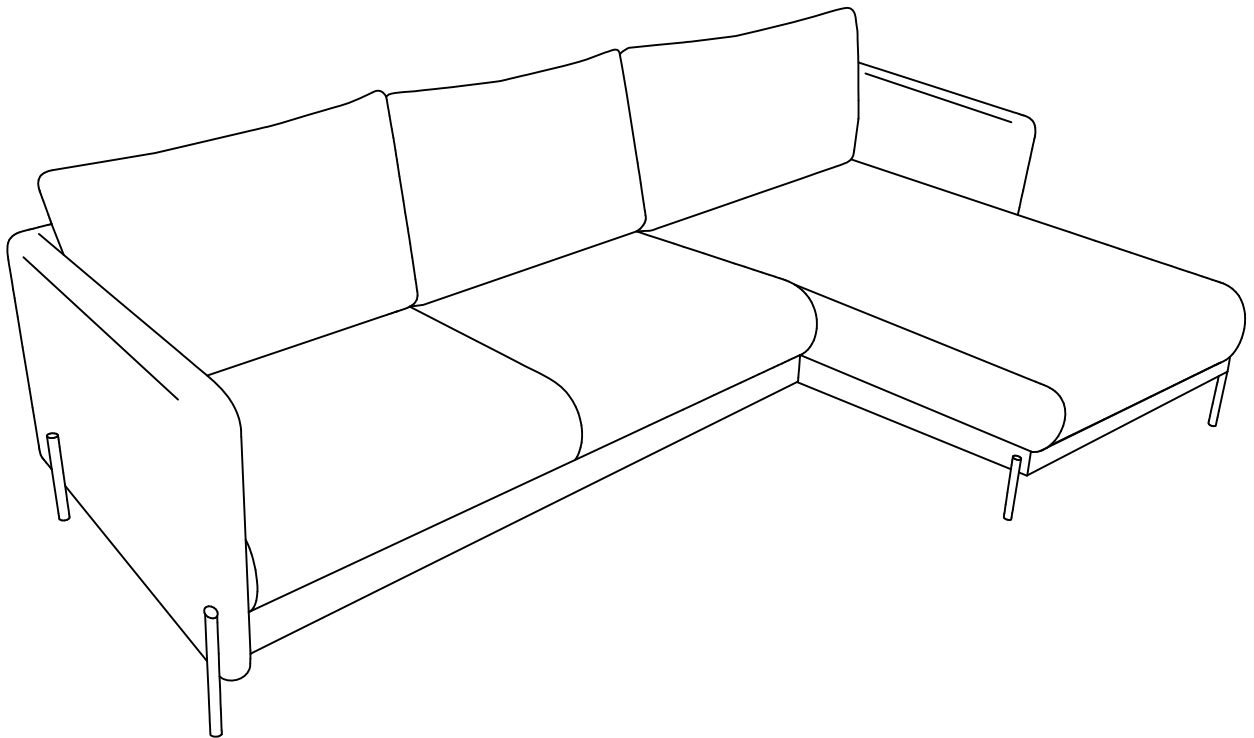

227 x 145 x 85 cm

Kære kunde

Tillykke med dit nye køb.
Følg disse råd og få det bedste resultat, når du samler produktet.

- Læs vejledningen grundigt, før du går i gang
- Find hjælp, hvis I skal være to til at samle møblet
- Tjek at pakken indeholder alle dele på materialeoversigten
- Saml møblet på et blødt underlag, så du undgår ridser
- Følg vejledningen nøje
- Gem denne vejledning

Afsæt tid

Nogle møbler kan samles på få minutter. Andre – der f.eks. består af flere dele – kan tage over en time at samle. Afsæt god tid eller gør evt. arbejdet af flere omgange.

Mangler du enkeltdele, eller har du spørgsmål til samlevejledningen? Så kontakt kundeservice på ilva.dk

Venlig hilsen
ILVA

Dear Customer

Congratulations on your new purchase.
Follow this advice and get the best result when assembling the product.

- Read the instruction carefully before you start
- Get help, If two persons are required for assembly
- Make sure, you have all parts on the total material list
- Work on a soft, flat surface to avoid any damage to the finish
- Follow the assembly instruction
- Keep the assembly instruction

Allocate time

Some furniture can be assembled in minutes. Others – e.g. products in several parts – can take more than an hour to finish. Make sure to allocate good time or divide up the work.

If any parts are missing or if you have questions for the assembly instruction, please contact customer support at ilva.dk

Best regards,
ILVA

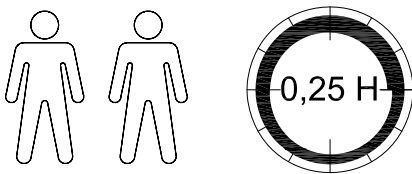

Tools needed

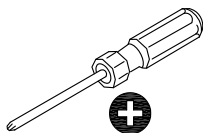

Don't use!!!

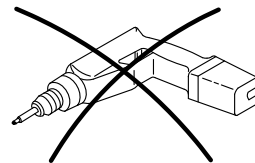

Total material list, hardware

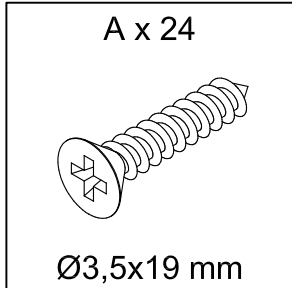

Total material list, furniture parts

			✓
①	1	1490x500x820	
②	1	780x500x1450	
③	3	720x450x210	
④	6	∅20x200x280	

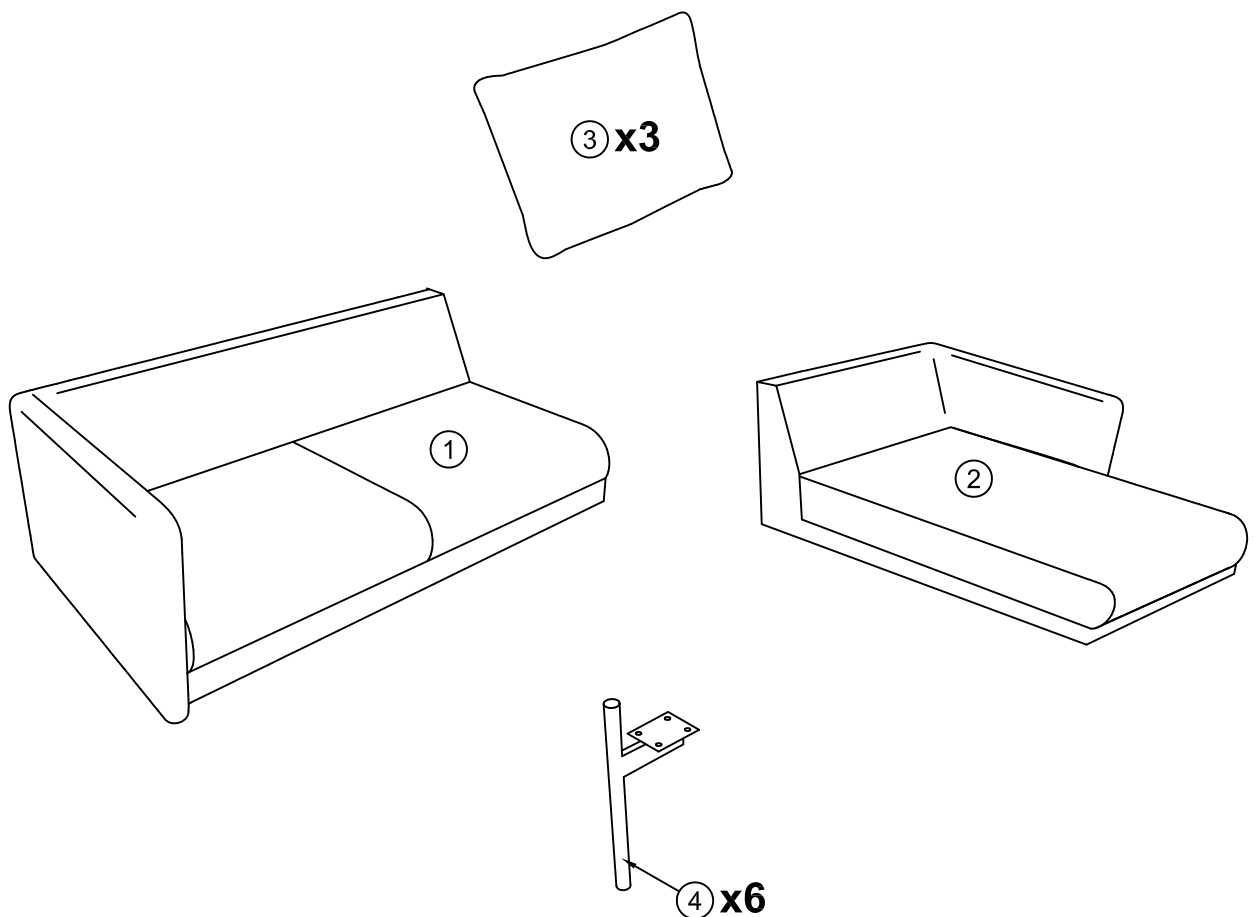

1

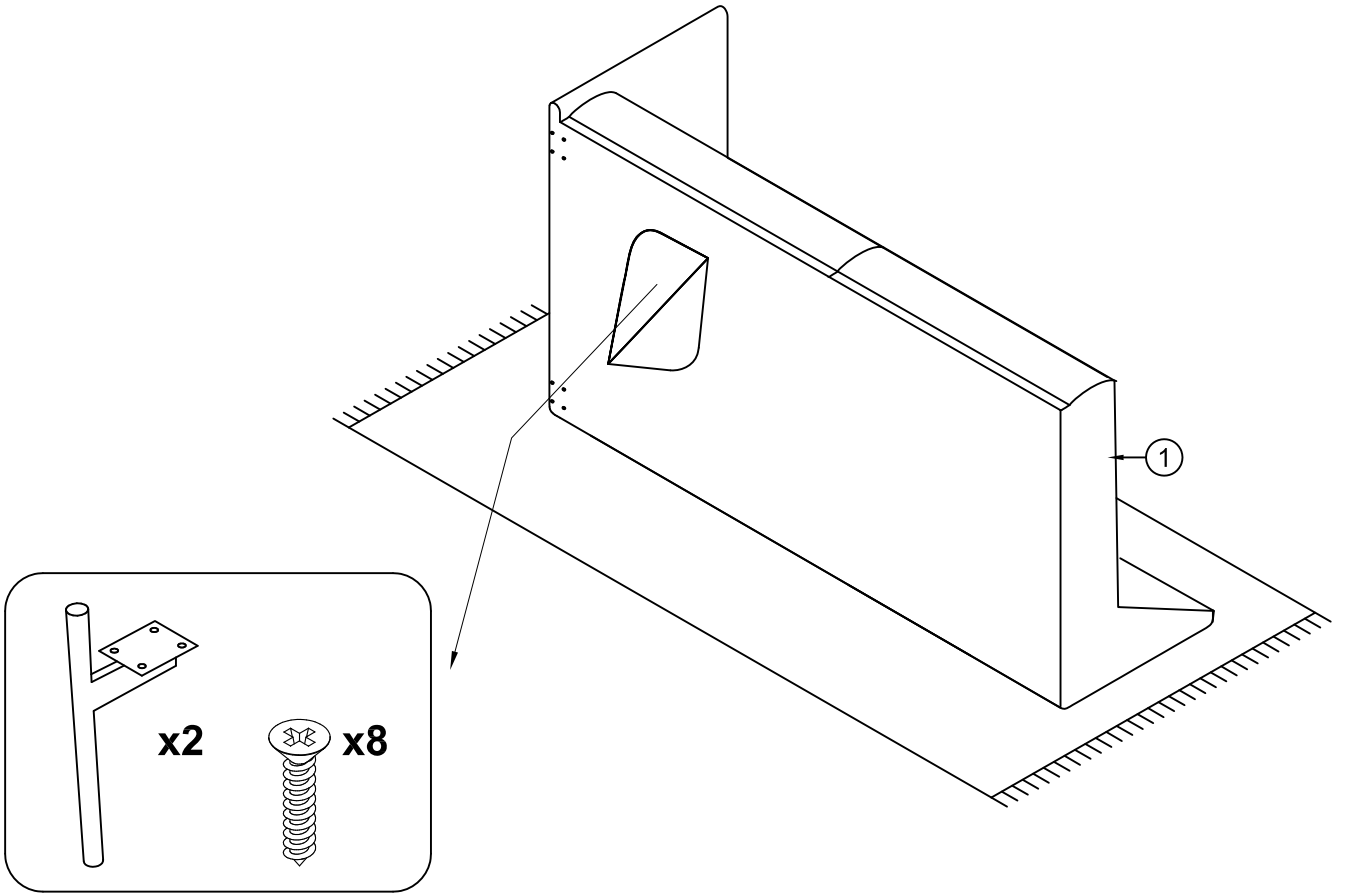

2

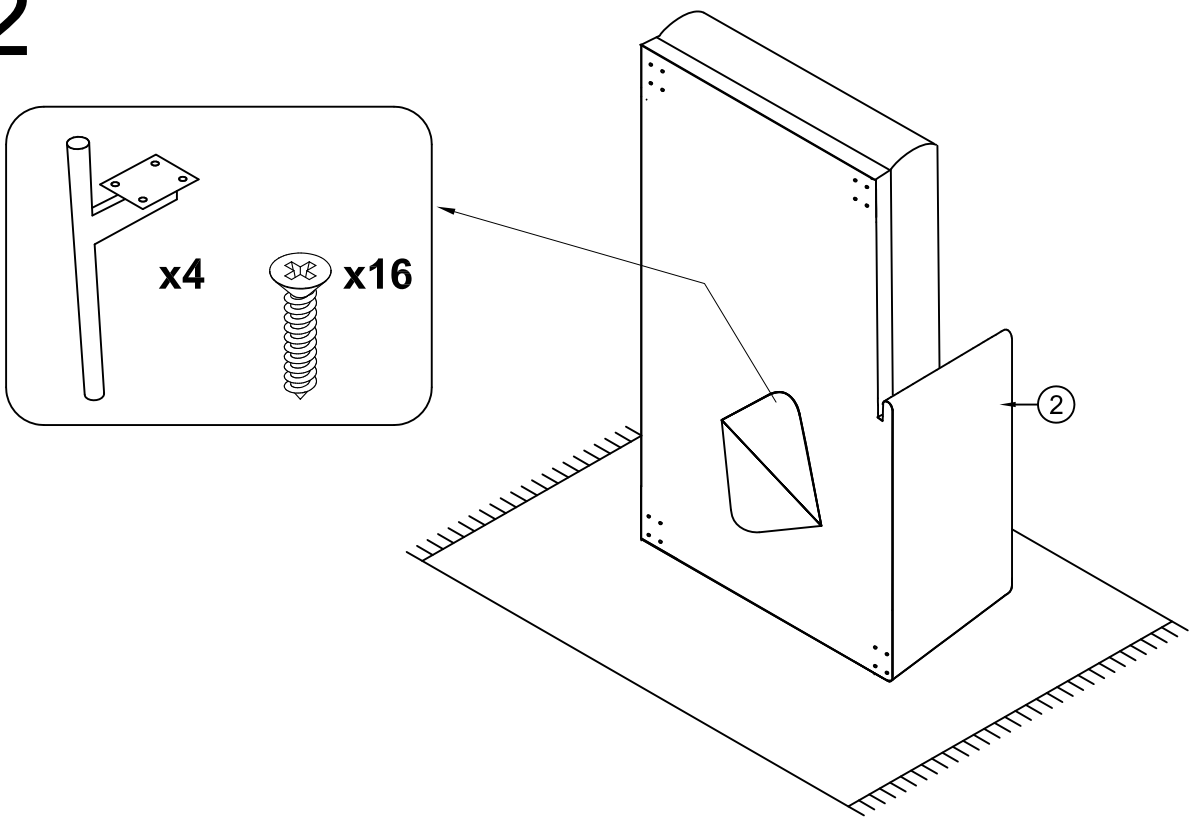

3

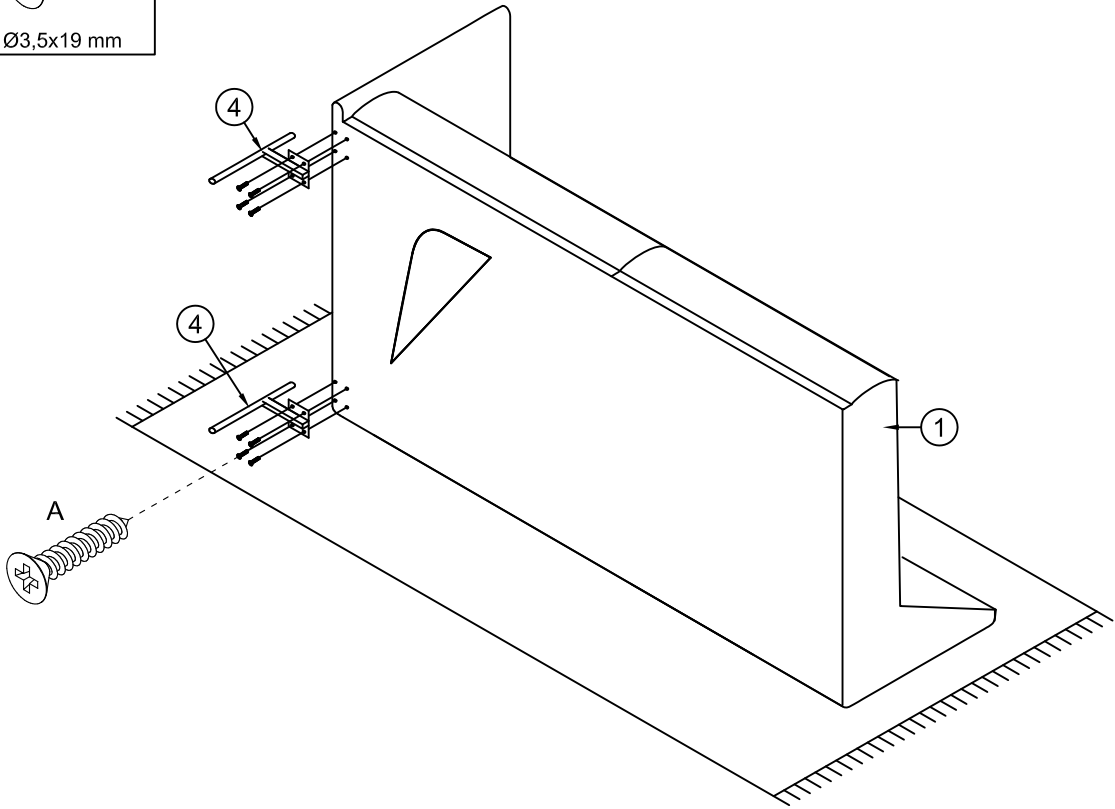
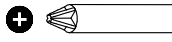
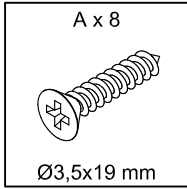

4

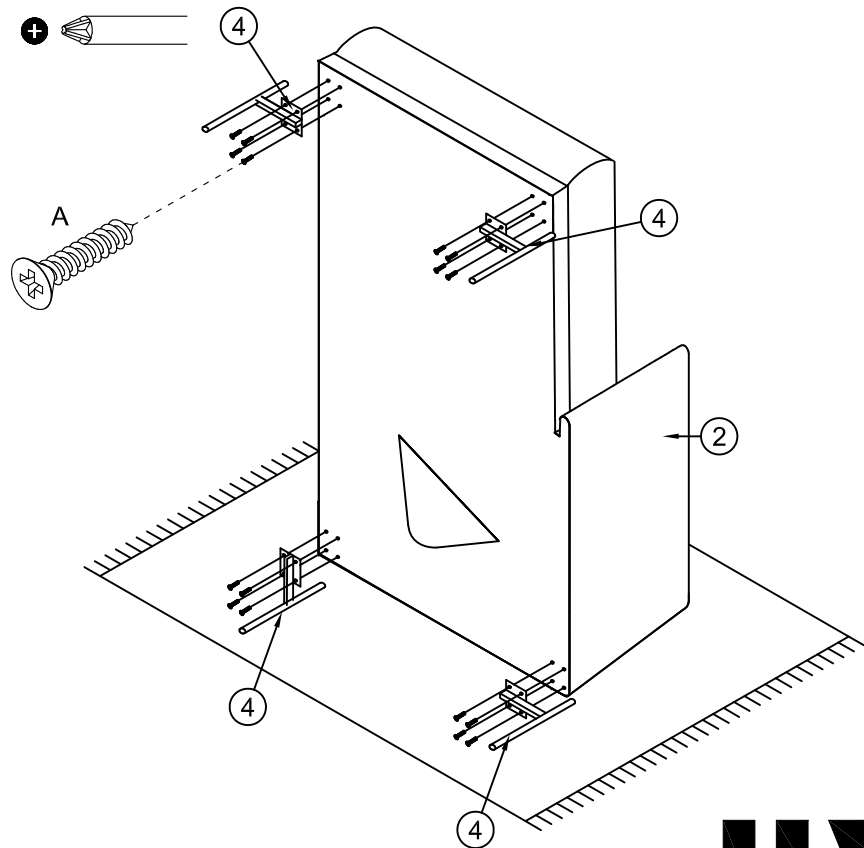
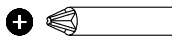
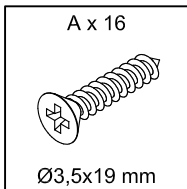

5

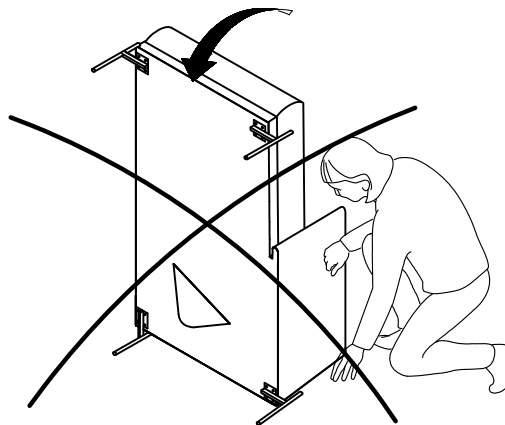
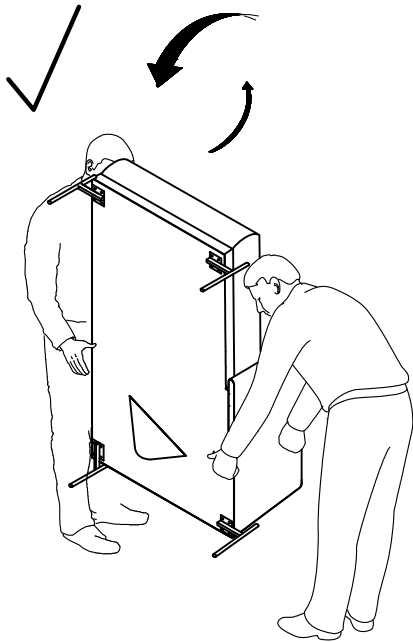
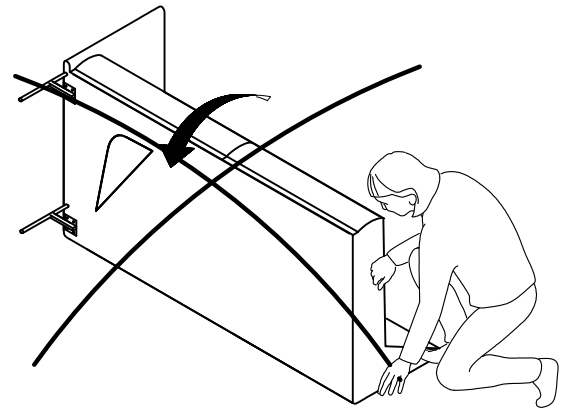
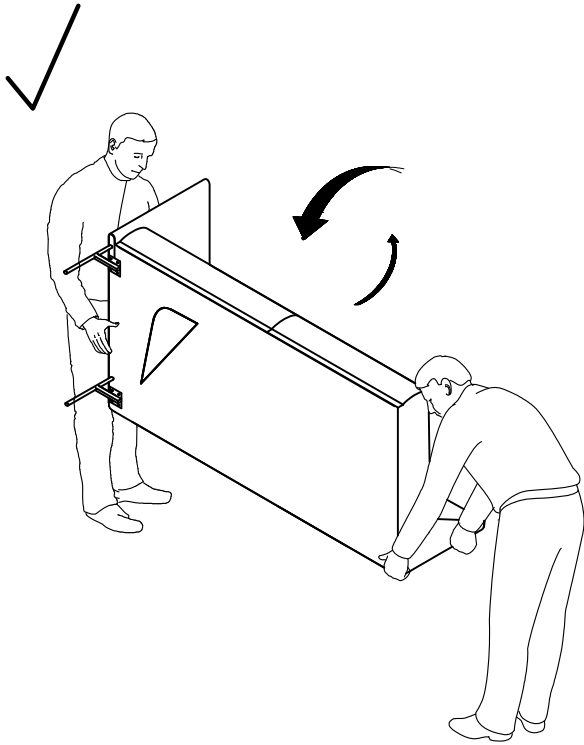

6

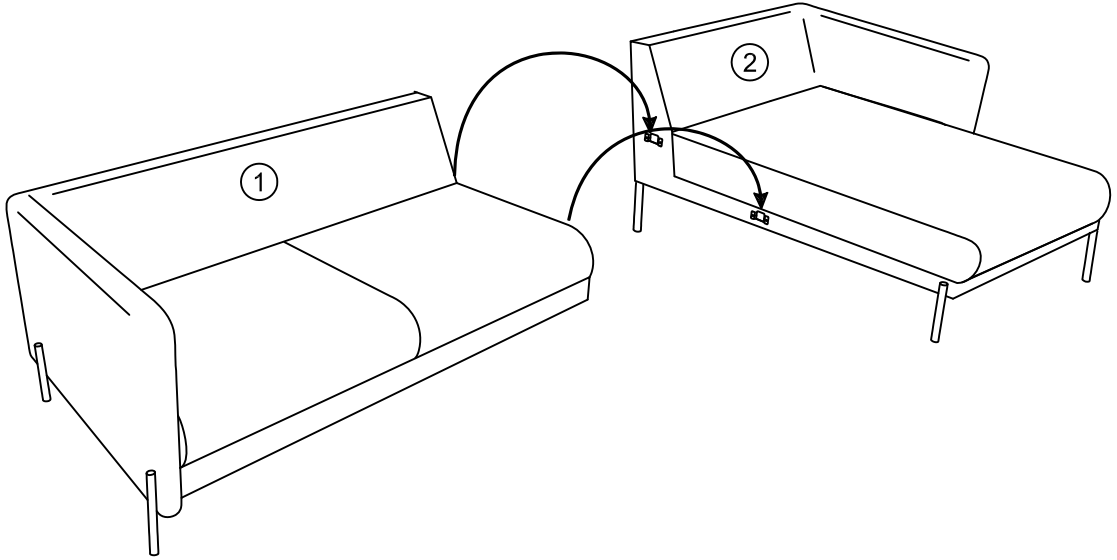

7

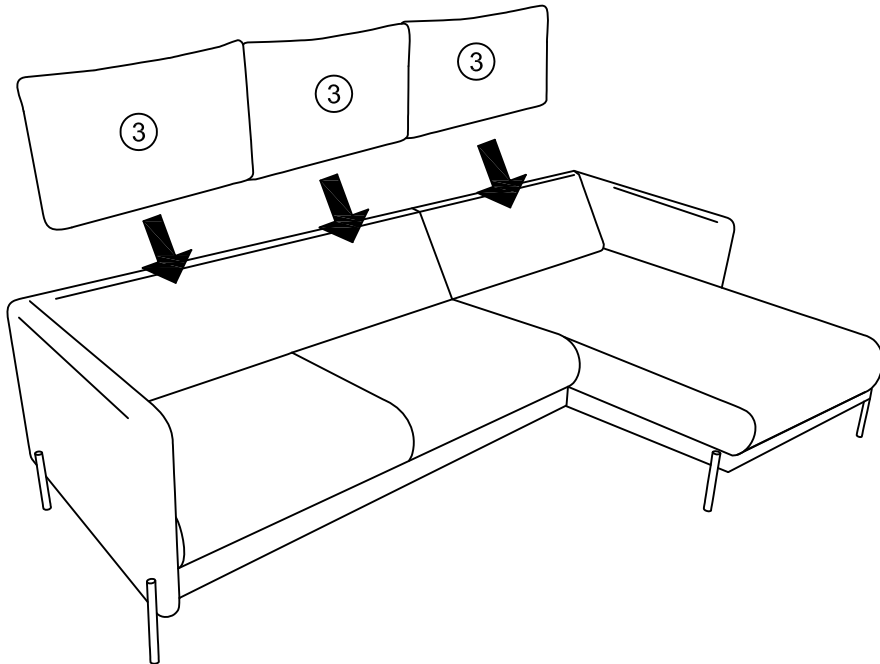

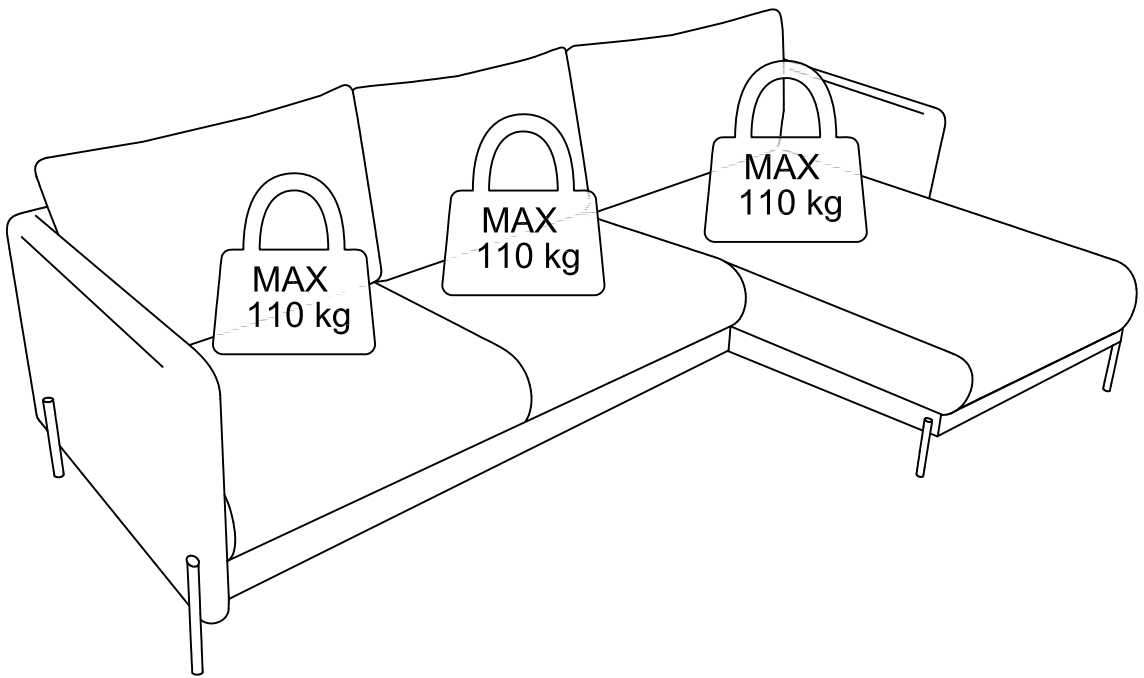

VIGTIGT!

Det er vigtigt, at alle produkter, der samles med alle former for skruer og ben, efterspændes **en måned** efter samling samt hver **tredje måned** for at sikre, at produktet er stabilt i hele dets levetid.

IMPORTANT!

It is important that any product which is assembled using any kind of screw and leg is re-tightened **one month** after assembly, and once every **3 months** - in order to assure stability through-out the lifespan of the product.

